

Drawn by LWf	Date 16 JUL 2020	Remarks	
Royal OTOLIFT Stairlifts Postbox 64 2860 AB Bergambacht The Netherlands Telephone: +31 182 352544 www.otolift.com	 ROYAL OTOLIFT STAIRLIFTS	Type	Scale N/A Units mm Size A3
		Serial No.	Order No. PL2020-221

DISCLAIMER: Dimensions are indicative. Differences may occur between drawing and installed product.

Property of OTOLIFT. Reproduction, reproduction or distribution of information in any form, without consent of the owner, is prohibited.

6020

L = 7,5  
# RAILPARTS = 1

WOOD, CONCRETE CASE

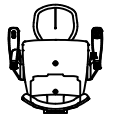

REVISION No. C DRAWN BY: GE DATE: 16-7-20  
Right hand version with extra CP

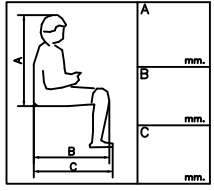
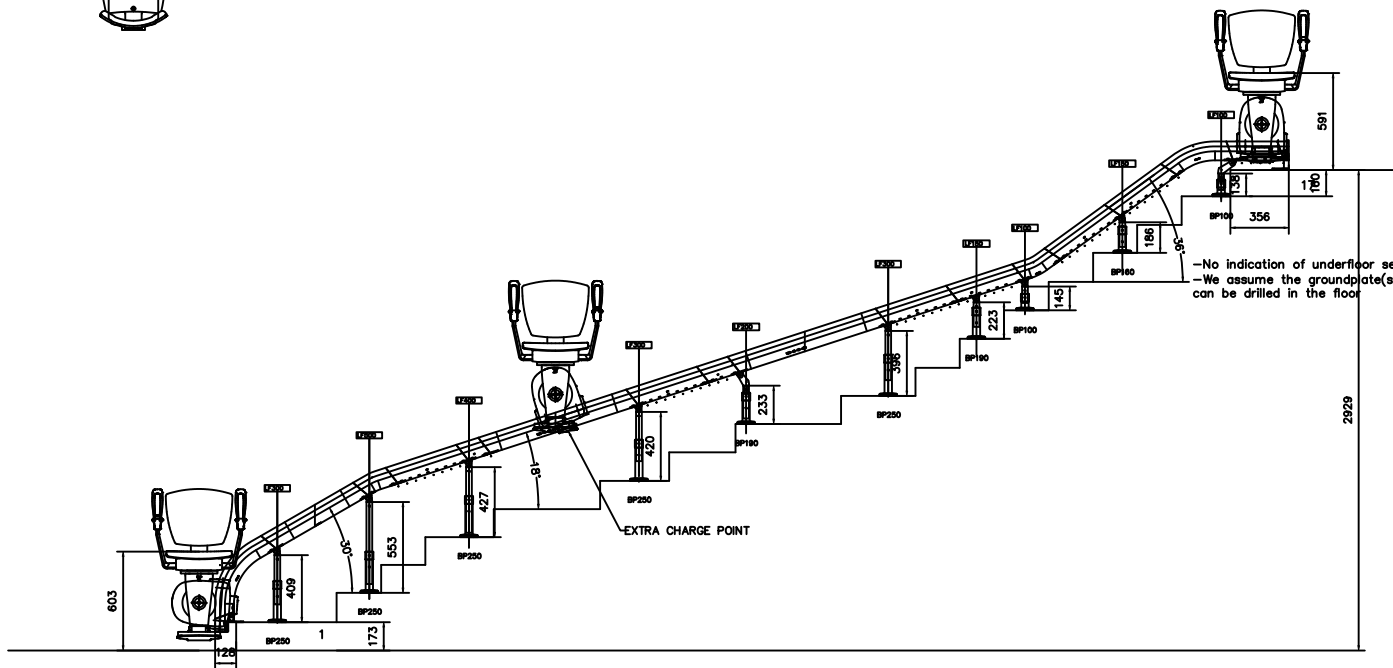

-No indication of underfloor services  
-We assume the groundplate(s)  
can be drilled in the floor

Drawn by <b>LWI</b> Royal OTOLIFT Stairlifts Postbox 64 2860 AB Bergambacht The Netherlands Telephone: +31 182 352544 www.otolift.com	Date <b>16 JUL 2020</b>	Remarks
Type  STAIRLIFTS	Scale Units Size N/A mm A3	Order No. PL2020-221

DISCLAIMER: Dimensions are indicative. Differences may occur between drawing and installed product.

Property of OTOLIFT. Reproduction or distribution of information in any form, without consent of the owner, is prohibited.

6020

L = 7,5  
# RAILPARTS = 1

WOOD, CONCRETE CASE

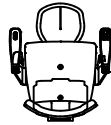

REVISION No. C DRAWN BY: GE DATE: 16-7-20  
Right hand version with extra CP

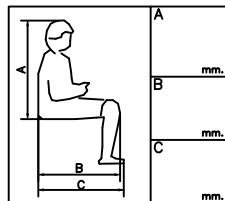
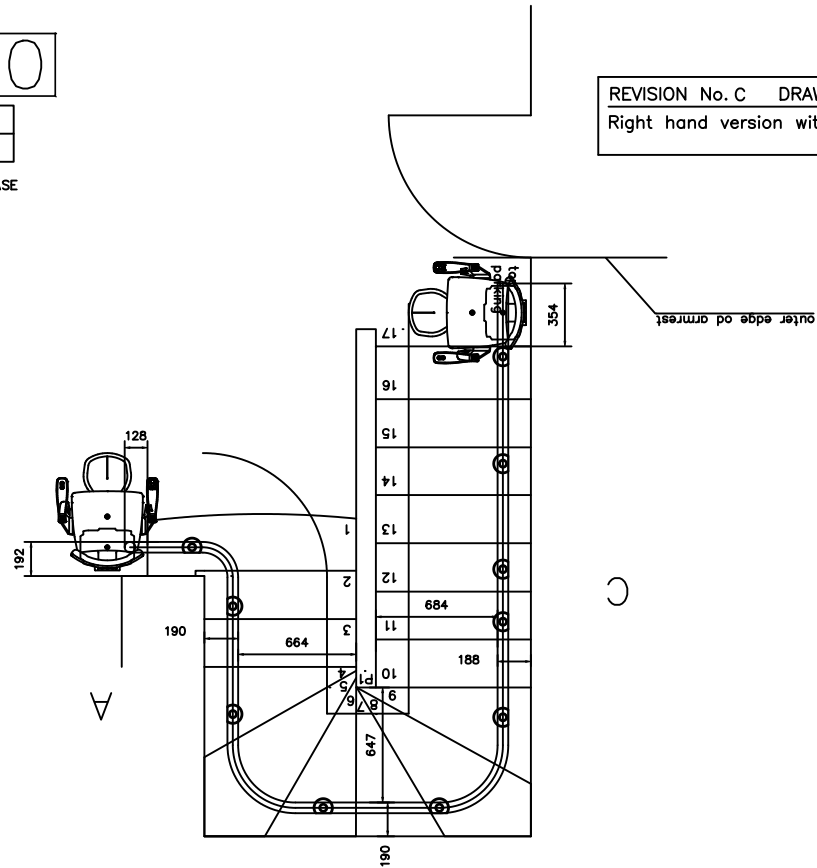

Drawn by LWi Royal OTOLIFT Stairlifts Postbox 64 2860 AB Bergambacht The Netherlands Telephone: +31 182 352544 www.otolift.com	Date 16 JUL 2020	Remarks
	Type	Scale N/A Units mm Size A3
Serial No.	Order No. PL2020-221	

DISCLAIMER: Dimensions are indicative. Differences may occur between drawing and installed product.

Property of OTOLIFT. Reproduction or distribution of information in any form, without consent of the owner, is prohibited.